

MP114E U-624 Rotation Stage User Manual

Version: 1.0.0

Date: 21.08.2015



This document describes the following product:

- **U-624.03**
PILine® rotation stage, small design, >360° rotation range, velocity 720°/s, incremental encoder, 35 μ rad resolution, 28.5 mm diameter, piezoelectric ultrasonic motor



Physik Instrumente (PI) GmbH & Co. KG is the owner of the following trademarks:
PI®, PIC®, PICMA®, PILine®, PIFOC®, PiezoWalk®, NEXACT®, NEXLINE®,
NanoCube®, NanoAutomation®, Picoactuator®, PInano®, PIMag®

PI owns the following patents or patent applications for the technology field Ultrasonic
Piezo Motors (PILine®):

Germany: DE102004024656A1, DE102004044184B4, DE102004059429B4,
DE102005010073A1, DE102005039357B4, DE102005039358A1,
DE102006041017B4, DE102008012992A1, DE102008023478A1,
DE102008058484A1, DE102010022812A1, DE102010047280A1, DE102010055848,
DE102011075985A1, DE102011082200A1, DE102011087542B3,
DE102011087542B3, DE102011087801B4, DE102011108175, DE102012201863B3,
DE19522072C1, DE19938954A1

Europe: EP0789937B1EP1210759B1, EP1267425B1, EP1581992B1, EP1656705B1,
EP1747594B1, EP1812975B1, EP1861740B1, EP1915787B2, EP1938397B1,
EP2095441B1, EP2130236B1, EP2153476B1, EP2164120B1, EP2258004B1,
EP2608286A2

USA: US2010/0013353A1, US5872418A, US6765335B2, US6806620B1,
US6806620B1, US7218031B2, US7598656B2, US7737605B2, US7795782B2,
US7834518B2, US7973451B2, US8253304B2, US8344592B2, US8482185B2

Japan: JP2011514131, JP2011522506, JP3804973B2, JP4377956, JP4435695,
JP4477069, JP4598128, JP4617359, JP4620115, JP4648391, JP4860862,
JP4914895, JP2013539346

China: ZL200380108542.0, ZL200580015994.3, ZL200580029560.9,
ZL200580036995.6, ZL200680007223.4, ZL200680030007.1, ZL200680042853.5

International patent applications: WO2009059939A2, WO2010121594A1,
WO2012048691A2, WO2012113394A1, WO2012155903A1, WO2013034146A3,
WO2013117189A2

© 2015 Physik Instrumente (PI) GmbH & Co. KG, Karlsruhe, Germany. The text, photographs and drawings in this manual are protected by copyright. With regard thereto, Physik Instrumente (PI) GmbH & Co. KG retains all the rights. The use of any text, images and drawings is permitted only in part and only when indicating the source.

Original instructions

First printing: 21.08.2015

Document number: MP114E, CBo, Version 1.0.0

Subject to change without notice. This manual is superseded by any new release. The latest release is available for download (p. 3) on our website.



Contents

1	About this Document	1
1.1	Objective and Target Audience of this User Manual	1
1.2	Symbols and Typographic Conventions	1
1.3	Definition	2
1.4	Figures	3
1.5	Other Applicable Documents	3
1.6	Downloading Manuals	3
2	Safety	5
2.1	Intended Use	5
2.2	General Safety Instructions	5
2.3	Organizational Measures	7
3	Product Description	9
3.1	Product View	9
3.2	Product Labeling	10
3.3	Scope of Delivery	11
3.4	Suitable Controllers	11
3.5	Accessories	12
3.6	Technical Features	12
3.6.1	Rotary Encoder	12
3.6.2	Reference Point Switch	12
3.6.3	ID Chip	12
4	Unpacking	13
5	Installation	15
5.1	General Notes on Installation	15
5.2	Mounting the U-624 on a Surface and Connecting It to a Protective Earth Conductor	17
5.3	Affixing the Load to the U-624	20
6	Start-Up and Operation	23
6.1	General Notes on Start-Up and Operation	23
6.2	Starting up the U-624	26

7	Maintenance	29
7.1	General Notes on Maintenance	29
7.2	Performing a Maintenance Run	29
7.3	Cleaning the U-624	30
8	Troubleshooting	31
9	Customer Service	33
10	Technical Data	35
10.1	Specifications	35
10.1.1	Data Table	35
10.1.2	Reference Point Switch Specifications	36
10.1.3	Maximum Ratings	36
10.2	Ambient Conditions and Classifications	37
10.3	Motor Power	38
10.3.1	Motor Power and Operating Voltage	38
10.3.2	Velocity and Torque	39
10.3.3	Motor Power and Lifetime	40
10.3.4	Influence of Downtimes on the Torque	41
10.4	Dimensions	42
10.5	Pin Assignment	43
11	Old Equipment Disposal	45
12	EC Declaration of Conformity	47

1 About this Document

In this Chapter

Objective and Target Audience of this User Manual	1
Symbols and Typographic Conventions	1
Definition	2
Figures	3
Other Applicable Documents	3
Downloading Manuals	3

1.1 Objective and Target Audience of this User Manual

This manual contains information on the intended use of the U-624.

It assumes that the reader has a fundamental understanding of basic servo systems as well as motion control concepts and applicable safety procedures.

The latest versions of the user manuals are available for download (p. 3) on our website.

1.2 Symbols and Typographic Conventions

The following symbols and typographic conventions are used in this user manual:

CAUTION



Dangerous situation

If not avoided, the dangerous situation will result in minor injury.

- Actions to take to avoid the situation.

NOTICE



Dangerous situation

If not avoided, the dangerous situation will result in damage to the equipment.

- Actions to take to avoid the situation.

INFORMATION

Information for easier handling, tricks, tips, etc.

Symbol/ Label	Meaning
1. 2.	Action consisting of several steps whose sequential order must be observed
➤	Action consisting of one or several steps whose sequential order is irrelevant
▪	List item
p. 5	Cross-reference to page 5
RS-232	Labeling of an operating element on the product (example: socket of the RS-232 interface)
	Warning signs affixed to the product that refer to detailed information in this manual.

1.3 Definition

Term	Explanation
Load capacity	Maximum load capacity in the vertical direction when the rotation stage is mounted horizontally. The contact point of the load is in the center of the platform.
Rotary encoder	The rotary encoder is an incremental sensor for capturing changes in position. Signals from the sensor are used for axis position feedback. After switching on the controller a reference point definition must be performed before absolute target positions can be commanded and reached.

1.4 Figures

For better understandability, the colors, proportions and degree of detail in illustrations can deviate from the actual circumstances. Photographic illustrations may also differ and must not be seen as guaranteed properties.

1.5 Other Applicable Documents

The devices and software tools which are mentioned in this documentation are described in their own manuals.

Description	Document
C-867.1U PLine® controller	MS223E user manual
C-867.2U PLine® controller	MS231E user manual
C-877.1U11 PLine® controller	MS232E user manual
C-877.2U12 PLine® controller	MS233E user manual
PIMikroMove	SM148E software manual
PLine® stage	MP121EK short instructions

1.6 Downloading Manuals

INFORMATION

If a manual is missing or problems occur with downloading:

- Contact our customer service department (p. 33).

INFORMATION

For products that are supplied with software (CD in the scope of delivery), access to the manuals is protected by a password. Protected manuals are only displayed on the website after entering the password.

The password is included on the CD of the product.

For products with CD: Identify the password

1. Insert the product CD into the PC drive.
2. Switch to the Manuals directory on the CD.
3. In the Manuals directory, open the Release News (file including **releasenews** in the file name).
4. Find the user name and the password in the section "User login for software download" in the Release News.

Downloading Manuals

1. Open the website **http://www.pi.ws**.
2. Click **Info**.
3. If you have a user name and password:
 - a) Click **Login**.
 - b) Log in with the user name and password.
4. Click **>> Product Downloads**.
5. In the **Product Files** area, click the corresponding product category.
6. On the right-hand side of the page, select the corresponding sub-category.
7. Navigate to the product code on the page.

The following manuals are displayed:

 - Freely accessible manuals
 - Manuals that are protected by a password
8. Click the desired manual and save it to the hard disk of your PC or to a data storage medium.

2 Safety

In this Chapter

Intended Use	5
General Safety Instructions	5
Organizational Measures.....	7

2.1 Intended Use

The U-624 is a laboratory device as defined by DIN EN 61010-1. It is intended for indoor and use in an environment that is free of dirt, oil and lubricants.

In accordance with its design, the U-624 is intended for single-axis positioning, adjustment and rotation of loads at different velocities in interval operation. The U-624 is **not** intended for applications in areas in which a failure would present severe risks to human beings or the environment.

The intended use of the U-624 is only possible when completely mounted and connected.

The U-624 uses a PLine® ultrasonic piezomotor as drive and must be operated with a suitable controller (p. 11). The controller is not included in the scope of delivery of the U-624.

2.2 General Safety Instructions

The U-624 is built according to state-of-the-art technology and recognized safety standards. Improper use can result in personal injury and/or damage to the U-624.

- Only use the U-624 for its intended purpose, and only use it if it is in a good working order.
- Read the user manual.
- Immediately eliminate any faults and malfunctions that are likely to affect safety.

The operator is responsible for the correct installation and operation of the U-624.

Piezomotors are driven by piezo actuators. After disconnection from the electronics, piezo actuators can remain electrically charged for several hours. Temperature changes can also induce charges in piezo actuators. Touching charged parts of the U-624 can cause slight injuries from electric shock.

- Do **not** open the U-624.
- Do **not** touch the contacts in the connector of the U-624.

If a protective earth conductor is not or not properly connected, dangerous touch voltages can occur on the U-624 in the case of malfunction or failure of the system. If touch voltages exist, touching the U-624 can result in minor injuries from electric shock.

- Connect the U-624 to a protective earth conductor (p. 17) before start-up.
- Do **not** remove the protective earth conductor during operation.
- If the protective earth conductor has to be removed temporarily (e. g. in the case of modifications), reconnect the U-624 to the protective earth conductor before starting it up again.

Mechanical forces can damage or misalign the U-624.

- Avoid impacts that affect the U-624.
- Do **not** drop the U-624.
- Do **not** exceed the maximum permissible stress and load capacities according to the specifications (p. 35).

2.3 Organizational Measures

User manual

- Always keep this user manual available with the U-624.
The latest versions of the user manuals are available for download (p. 3) on our website.
- Add all information from the manufacturer to the user manual, for example supplements or Technical Notes.
- If you give the U-624 on to other users, also include this user manual as well as other relevant information provided by the manufacturer.
- Only use the device on the basis of the complete user manual. Missing information due to an incomplete user manual can result in minor injury and damage to equipment.
- Only install and operate the U-624 after you have read and understood this user manual.

Personnel qualification

The U-624 may only be installed, started up, operated, maintained and cleaned by authorized and appropriately qualified personnel.

3 Product Description

In this Chapter

Product View	9
Product Labeling.....	10
Scope of Delivery	11
Suitable Controllers	11
Accessories	12
Technical Features	12

3.1 Product View

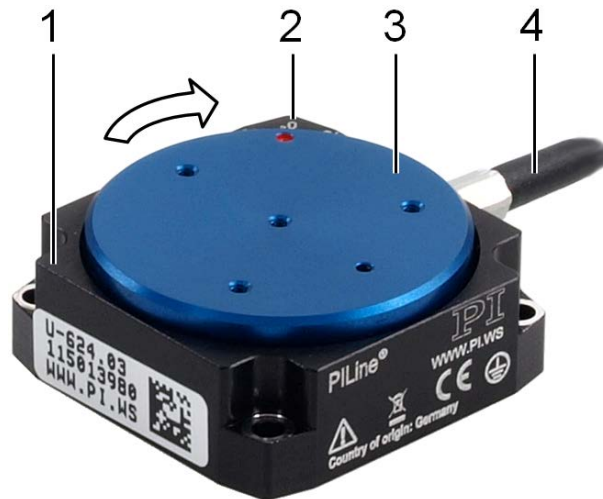

Figure 1: U-624 product view

- 1 Base body
- 2 0° mark: After a reference move of the U-624, the red point on the moving platform is above the 0 mark in the base body.
- 3 Moving platform
- 4 Cable for connection to the controller

The arrow in the figure shows the positive direction of motion.

3.2 Product Labeling

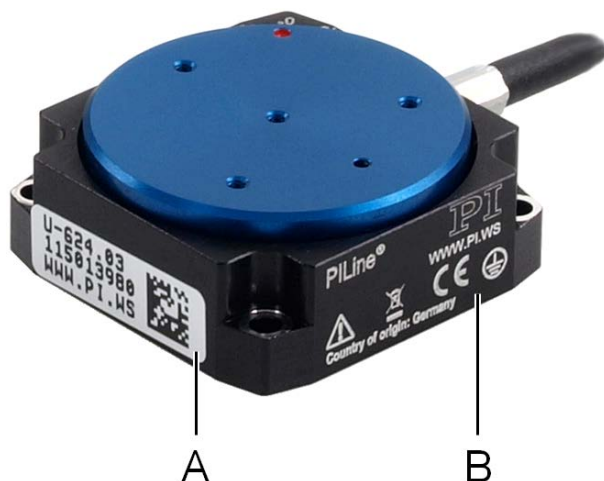

Figure 2: U-624: Position of the product labeling (example view)







Position	Labeling	Description
A	U-624.03	Product name
A	115013980	Serial number (example), individual for each U-624 Meaning of the places (counting from left): 1 = internal information 2 and 3 = year of manufacture 4 to 9 = consecutive numbers
A, B	WWW.PI.WS	Manufacturer's address (website)
A		Data matrix code (example; contains the serial number)
B	PILine®	Brand name
B		Manufacturer's logo
B		Warning sign "Observe manual!"
B		Old equipment disposal (p. 45)
B		CE conformity mark
B		Symbol for the protective earth conductor (p. 17)
B	Country of origin: Germany	Country of origin



Figure 3: U-624: "Residual voltage" warning sign on connector

Warning sign "Residual voltage": Notice of risk of electric shock (p. 5)

3.3 Scope of Delivery

Item ID	Components
U-624.03	PILine® rotation stage, small design, >360° rotation range, velocity 720°/s, incremental encoder, 35 µrad resolution, 28.5 mm diameter, piezoelectric ultrasonic motor
1474	4 socket head cap screws M2x10, ISO 4762, for mounting the U-624
3109	Allen wrench AF 1.5
MP121EK	Short instructions for the PILINE® stage

3.4 Suitable Controllers

Order Number	Description
C-867.1U	Piezomotor controller / driver, networkable, 1 channel, for PILINE® systems with Sub-D connector(s)
C-867.2U	Piezomotor controller with drive electronics, networkable, 2 channels, for PILINE® systems with Sub-D connector(s)
C-877.1U11	Compact, cost-efficient piezomotor controller with drive electronics, 1 channel, for PILINE® systems with low power consumption
C-877.2U12	Compact piezomotor controller with drive electronics, 2 channels, for PILINE® systems

- To order, contact our customer service department (p. 33).

3.5 Accessories

Order Number	Description
U-600.A01	Extension cable for PLine®, 15-pin Sub-D, 1 m*
U-600.A03	Extension cable for PLine®, 15-pin Sub-D, 3 m*
U-600.A05	Extension cable for PLine®, 15-pin Sub-D, 5 m*

* Other cable lengths available on request.

- To order, contact our customer service department (p. 33).

3.6 Technical Features

3.6.1 Rotary Encoder

The U-624 is equipped with an optical rotary encoder. For the encoder resolution, refer to the table in the "Specifications" section (p. 35).

Optical rotary encoders measure the actual position directly (direct metrology). Therefore, errors occurring in the drivetrain, such as nonlinearity, backlash or elastic deformation, cannot influence the measurement of the position.

3.6.2 Reference Point Switch

The U-624 has an optical reference point switch (see "Reference Switch Specifications", p. 36).

See the controller user manual and/or associated software manuals for the commands which make use of the reference point signal.

After a reference move of the U-624, the red dot on the moving platform is above the 0° mark in the base body.

3.6.3 ID Chip

The connector of the U-624 stages contains an ID chip. Information on the stage (e.g., type, serial number, date of manufacture, version of the hardware) is stored in parameters on the ID chip.

When switched on or rebooted, controllers from PI read the data from the ID chip.

For more information on the ID chip recognition, see the manual of the controller used.

4 Unpacking

1. Unpack the U-624 with care.
2. Compare the contents with the items listed in the contract and the packing list.
3. Inspect the contents for signs of damage. If parts are missing or you notice signs of damage, contact PI immediately.
4. Keep all packaging materials in case the product needs to be returned.

5 Installation

In this Chapter

General Notes on Installation	15
Mounting the U-624 on a Surface and Connecting It to a Protective Earth Conductor	17
Affixing the Load to the U-624	20

5.1 General Notes on Installation

CAUTION



Dangerous voltage and residual charge on piezo actuators!

Piezomotors are driven by piezo actuators. After disconnection from the electronics, piezo actuators can remain electrically charged for several hours. Temperature changes can also induce charges in piezo actuators. Touching or short-circuiting the contacts in the connector of the U-624 can lead to minor injuries from electric shock.

- Do **not** touch the contacts in the connector of the U-624.

NOTICE



Lubricants, dirt, condensation!

Dirt, oil, lubricants and condensation will render the motor/drive inoperable.

- Ensure that the piezomotor of the U-624 does not come into contact with lubricants.
- Keep the U-624 free from dirt and condensation.

NOTICE



Heating up of the U-624 during operation!

The heat produced during operation of the U-624 can affect your application.

- Install the U-624 so that your application is not affected by the dissipating heat.

NOTICE**Unsuitable cables!**

Unsuitable cables can cause damage to the controller and affect the performance of the U-624.

- Only use genuine PI parts to connect the U-624 to the controller.
- If you need longer cables, use extension cables from PI (p. 12).

NOTICE**Unintentional changes in position with vertical mounting!**

If the load exceeds the maximum torque of the drive when the rotation stage is mounted vertically, unintentional changes in the position of the moving platform occur. Unintentional changes in position of the moving platform can damage the drive, the load or the environment.

- When a rotation stage is mounted vertically, make sure that the installed load is lower than the maximum torque of the drive (p. 35).

INFORMATION

For optimum repeatability, all components must be firmly affixed to each other.

INFORMATION

When manually displacing the moving platform in a de-energized state, differences in the holding force may be noticeable across the travel range.

There are mechanical reasons for fluctuations in the holding force and they have no influence on the function of the stage.

- If possible, simulate the rotation stage motions with a mounted load or make suitable calculations in order to identify collisions or unfavorable center of gravity constellations.
- If necessary, take suitable constructive measures to avoid collisions and instabilities in the overall system.

- Avoid or mark danger zones that result from the installation of the rotation stage and the application, in accordance with the legal regulations.

For more information on operating conditions, refer to the "Motor Power" section (p. 38).

5.2 Mounting the U-624 on a Surface and Connecting It to a Protective Earth Conductor

NOTICE



Warping of the base body!

Incorrect mounting can warp the base body. Warping of the base body will increase wear and reduce accuracy.

- Mount the U-624 on an even surface. The recommended evenness of the surface is 10 µm.
- For applications with large temperature changes:
Only fasten the U-624 to surfaces that have the same or similar thermal expansion properties as the U-624 (e.g. surfaces made of aluminum).

INFORMATION

Contact of the U-624 with the protective earth conductor is made as follows:

- Two mounting holes in the base body of the U-624
- Suitable conductive screws (p. 11)
- Protective earth conductor connected to the surface on which the U-624 is mounted

INFORMATION

- Observe the applicable standards for mounting the protective earth conductor.

INFORMATION

The positive direction of motion of the U-624 is shown in the product view (p. 9).

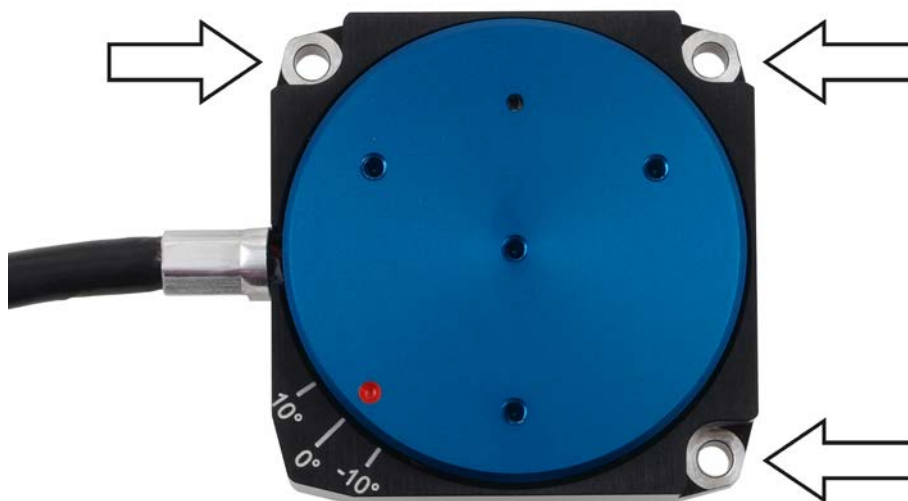

Figure 4: Mounting holes for mounting the U-624 on a surface

Prerequisites

- ✓ You have read and understood the general notes on installation (p. 15).
- ✓ You have provided a suitable surface (for the required position of the holes for accommodating the screws, see "Dimensions" (p. 42)).
 - The surface is connected to a protective earth conductor.
 - Three M2 holes with a thread depth of at least 6 mm are present.
 - The holes for accommodating the screws are sufficiently conductive to ensure proper function of the protective earth conductor.
 - The evenness of the surface is $\leq 10 \mu\text{m}$.
 - For applications with large temperature changes: The surface should have the same thermal expansion properties as the U-624 (e.g., surface made of aluminum).
- ✓ You have accounted for the space required to route cables without bending and according to regulations.
- ✓ The U-624 is **not** connected to the controller.

Tools and accessories

- Suitable protective earth conductor: Cross-sectional area of the cable $\geq 0.75 \text{ mm}^2$
- Mounting accessories in the scope of delivery (p. 11):
 - 3 M2x10 screws
 - Allen wrench

Mounting the U-624 on a surface and connecting it to a protective earth conductor

1. Align the U-624 on the surface so that the corresponding holes in the U-624 and the surface overlap.
2. Insert the three screws into the holes in the base body of the U-624.
3. Tighten the three screws with a torque of 20 Ncm each.
4. Make sure that the contact resistance at all connection points relevant for mounting the protective earth conductor. is $< 0.1 \Omega$ at 25 A.
5. Check that the U-624 is affixed firmly to the surface.

5.3 Affixing the Load to the U-624

NOTICE



Impermissibly high forces and torques!

Impermissibly high forces and torques that are applied to the moving platform can damage the U-624.

- For affixing type and mass of the load, observe the maximum permissible forces according to the specifications (p. 35).
- Avoid tilting torques >0.01 Nm on the moving platform.

NOTICE



Screws that are too long!

The U-624 can be damaged by screws that are too long.

- Note the depth of the mounting holes in the moving platform (p. 42).
- Only use screws of the correct length for the respective mounting holes.

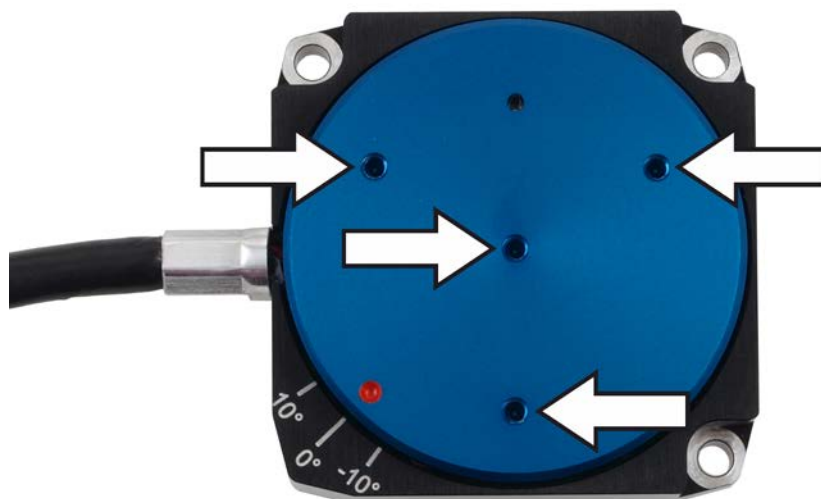

Figure 5: U-624, M1.6 holes for affixing the load

Prerequisites

- ✓ You have read and understood the general notes on installation (p. 15).
- ✓ You have properly attached the U-624 to a surface.
- ✓ The U-624 is **not** connected to the controller.
- ✓ You have prepared the load so that it can be affixed to the mounting holes on the moving platform:
 - The distance between the center of gravity of the load and the center of the moving platform is as small as possible in all directions.
 - At least three points are provided for affixing the load on the moving platform.

Tools and accessories

- At least three M1.6 screws of suitable length (p. 42)
- Suitable tools for tightening the screws

Affixing the Load

1. Align the load on the U-624 so that the mounting holes in the load and the holes in the moving platform overlap.
2. Affix the load with at least three screws.
3. Check that the load is affixed firmly to the moving platform of the U-624.

6 Start-Up and Operation

In this Chapter

General Notes on Start-Up and Operation	23
Starting up the U-624	26

6.1 General Notes on Start-Up and Operation

CAUTION



Risk of electric shock if the protective earth conductor is not connected!

If a protective earth conductor is not or not properly connected, dangerous touch voltages can occur on the U-624 in the case of malfunction or failure of the system. If touch voltages exist, touching the U-624 can result in minor injuries from electric shock.

- Connect the U-624 to a protective earth conductor (p. 17) before start-up.
- Do **not** remove the protective earth conductor during operation.
- If the protective earth conductor has to be removed temporarily (e. g. in the case of modifications), reconnect the U-624 to the protective earth conductor before starting it up again.

NOTICE



Damage if an incorrect controller is connected!

Connecting a rotation stage to an unsuitable controller can cause damage to the rotation stage or controller.

- Only connect the rotation stage with PLine® ultrasonic piezomotors to PLine® controllers (p. 11).

NOTICE**Operating voltage too high or incorrectly connected!**

Operating voltages that are too high or incorrectly connected can cause damage to the U-624.

- Only operate the U-624 with controllers/drivers and original accessories from PI.
- Do **not** exceed the operating voltage range (p. 36) for which the U-624 is specified.
- Only operate the U-624 when the operating voltage is properly connected; see "Pin Assignment" (p. 43).

NOTICE**Unintentional motions!**

When the U-624 is being connected to the controller, it can carry out unintentional motions. Defective software or wrong operation of the software can also result in unintentional motions.

- Do not place any objects in areas where they can be caught by moving parts.
- Before connecting the U-624, check whether a macro is defined as the start-up macro in the controller, and cancel the selection of the start-up macro if necessary.

NOTICE**Damage from collisions!**

Collisions can damage the rotation stage, the load to be moved and the environment.

- Make sure that no collisions are possible between the rotation stage, the load to be moved and the environment in the motion range of the rotation stage.
- Do not place any objects in areas where they can be caught by moving parts.
- Stop the motion immediately if a controller malfunction occurs.
- If possible, adapt the travel range limits of your mechanical system in the software that you use for commanding the motion.

NOTICE**Uncontrolled oscillation!**

Your application can be damaged by uncontrolled oscillation of the U-624. If you encounter noise during operation:

- Immediately switch off the servo-control system of the affected axes.
- Check the settings of the servo-control parameters.

NOTICE**Overheating during continuous operation!**

The highest torque or holding force is reached at maximum motor power; however, the U-624 may overheat during continuous operation.

- Observe the recommended motor power depending on the duty cycle and the ambient temperature (p. 40).

NOTICE**Damage or considerable wear from high accelerations!**

High accelerations can cause damage to or considerable wear on the mechanical system.

- Stop the motion immediately if a controller malfunction occurs.
- Determine the maximum velocity for your application.
- Observe the information in the "Motor Power" section (p. 38).

INFORMATION

Although in theory the U-624 operates quietly, noise levels of up to 50 dB (A) are possible during operation. The ultrasonic drive of the U-624 can also generate higher noise levels at frequencies between 100 and 500 kHz.

INFORMATION

The positive direction of motion of the U-624 is shown in the product view (p. 9).

INFORMATION

For maximum force generation, a run-in procedure is necessary during the start-up of the U-624 and after longer downtimes; see also "Influence of Downtimes on the Torque" (p. 41). The U-624 reaches its maximum torque after the run-in procedure.

- For run-in, command a few motion cycles at low velocity. The motion cycles should comprise full revolutions if possible.

For more information on operating conditions, refer to the "Motor Power" section (p. 38).

6.2 Starting up the U-624

NOTICE**Incorrect parameter settings!**

If you use the software which is included in the scope of delivery of the controller (p. 11), the operating parameters of the U-624 can be loaded from a stage database. The *PIStages2.dat* stage database contains the default parameter values of your rotation stage for performing initial test motions during start-up. Depending on the application, using the default parameter values (e. g., for P term, I term, D term, acceleration and velocity) can cause damage to the rotation stage, especially when operated with heavy loads.

- If possible: Perform the first start-up without a load.
- Always install the latest version of the *PIStages2.dat* stage database onto your PC.

For start-up with a load:

- Before start-up, make sure that the U-624 has been properly installed (p. 15).
- For optimum performance of the moving axis, adjust the operating parameters of the controller (e.g., P term, I term, D term, acceleration, velocity; see controller manual).
- Save the new parameter values to a stage database on the PC or to the nonvolatile memory of the controller for future use (see controller manual and PIMikroMove manual).

INFORMATION

If the total cable length between the stage and the controller is more than 3 m, it is necessary to adjust the parameter values in the controller for optimum motor power. The default parameter values in the *PIStages2.dat* stage database are suitable for a total cable length of 3 m.

Total cable length of 3 m to 6.5 m:

1. Adjust the value of the **Frequency Shift** parameter (ID 0x64) in the controller. Possible values: 20, 15, 10, 5, 0, -5, -10, -15, -20.
2. Repeat step 1 until the U-624 has reached optimum motor power.
3. Save the new parameter values to a stage database on the PC or the nonvolatile memory of the controller for future use (see controller manual and PIMikroMove manual).

Total cable length >6.5 m:

- Contact our customer service department (p. 33).

Prerequisites

- ✓ You have read and understood the general notes on start-up and operation (p. 23).
- ✓ You have read and understood the user manual of the controller (p. 3).
- ✓ In the case of start-up with a load: The U-624 has been properly installed (p. 15).
- ✓ The controller (p. 11) and the required software have been installed. All connections on the controller have been set up (see controller manual).

Starting up the U-624

- Start up the axis (see controller manual). Start-up involves the following steps:
 - Selecting the stage type
 - Defining the reference point of the axis
 - Commanding initial motions in closed-loop operation for testing and for run-in of the mechanical system

The controller manual describes start-up using the PIMikroMove program.

7 Maintenance

In this Chapter

General Notes on Maintenance.....	29
Performing a Maintenance Run.....	29
Cleaning the U-624.....	30

7.1 General Notes on Maintenance

NOTICE



Damage due to improper maintenance!

Improper maintenance can result in the failure of the U-624.

- Only loosen screws according to the instructions in this manual.
- Ensure that the piezomotor of the stage does not come into contact with lubricants.

7.2 Performing a Maintenance Run

Depending on the operating conditions and the period of use of the U-624, a maintenance run may be required. The maintenance run is performed to redistribute the existing lubricant on the bearings of the U-624 and must rotate at least one full turn.

- To evenly distribute the existing lubricant on the stage bearings, perform a maintenance run after 500 hours of operation or after 1 year at the latest.
- If you operate the U-624 continuously over a small working range ($<20^\circ$), perform a maintenance run each time after 5000 motion cycles.

7.3 Cleaning the U-624

Prerequisites

- ✓ You have disconnected the rotation stage from the controller.

Cleaning the rotation stage

- When necessary, clean the rotation stage surface with a cloth lightly dampened with a mild cleanser or disinfectant.

8 Troubleshooting

Problem	Possible Causes	Solution
Noise during operation	Uncontrolled oscillation of the U-624	<ul style="list-style-type: none"> ➤ Immediately switch off the servo-control system of the affected axes. ➤ Check the settings of the servo-control parameters.
Rotation stage positions inaccurately	Settling window around the target position is too large	<ul style="list-style-type: none"> ➤ Reduce the settling window by changing the parameter values for the settling window limits on the controller. See the controller user manual (p. 3) for details.
Reaching the target position takes too long	Settling window around the target position is too small	<ul style="list-style-type: none"> ➤ Enlarge the settling window by changing the parameter values for the settling window limits on the controller. See the controller user manual (p. 3) for details.
Increased wear Reduced accuracy	Warped base body	<ul style="list-style-type: none"> ➤ Mount the U-624 on an even surface. The recommended evenness of the surface is 10 µm. ➤ For applications with large temperature changes: Only mount the U-624 on surfaces that have the same or similar thermal expansion properties as the U-624 (e.g. surfaces made of aluminum).

Problem	Possible Causes	Solution
No or limited motion	Excessive load	<ul style="list-style-type: none"> ➤ Reduce the load (see "Data Table", p. 35). ➤ When the rotation stage is mounted vertically, make sure that the installed load is lower than the maximum torque of the drive (p. 35).
	The default parameter values are not suitable for operating with high loads	<ul style="list-style-type: none"> ➤ Adjust the operating parameters according to the description in "Starting up the U-624".
	The default parameter values are not suitable for cables longer than 3 m	<ul style="list-style-type: none"> ➤ Adjust the operating parameters according to the description in "Starting up the U-624".

If the problem that occurred with your system is not listed in the table above or cannot be solved as described, contact our customer service department (p. 33).

9 Customer Service

For inquiries and orders, contact your PI sales engineer or send us an e-mail (info@pi.ws).

- If you have questions concerning your system, have the following information ready:
 - Product codes and serial numbers of all products in the system
 - Firmware version of the controller (if present)
 - Version of the driver or the software (if present)
 - Operating system on the PC (if present)
- If possible: Take photographs or make videos of your system that can be sent to our customer service department if requested.

The latest versions of the user manuals are available for download (p. 3) on our website.

10 Technical Data

In this Chapter

Specifications	35
Ambient Conditions and Classifications	37
Motor Power	38
Dimensions	42
Pin Assignment.....	43

10.1 Specifications

10.1.1 Data Table

	U-624.03	Unit	Tolerance
Active axes	θ_z		
Motion and Positioning			
Rotation range	>360	°	
Integrated sensor	Incremental encoder		
Design resolution	35	μrad	
Min. incremental motion	105	μrad	typ.
Bidirectional repeatability	± 210	μrad	
Velocity	720	°/s	max.
Mechanical Properties			
Load capacity / axial force	1	N	max.
Holding torque	0.01	Nm	max.
Torque cw / ccw (θ_z)	0.01	Nm	max.
Drive Properties			
Motor type	PILine® ultrasonic piezomotor, performance class 1		
Reference point switches	Optical		

	U-624.03	Unit	Tolerance
Miscellaneous			
Operating temperature range	0 to 40	°C	
Material	Al (black anodized)		
Mass	130	g	±5 %
Cable length	1.5	m	typ.
Connector	Sub-D connector, 15-pin (m)		
Recommended controller / driver	C-877.1U11: 1 channel, affordable compact device C-877.2U12: 2 channels, affordable bench-top C-867.1U: 1 channel C-867.2U: 2 channels		

Ask about custom designs!

10.1.2 Reference Point Switch Specifications

Type	Optical sensor
Supply voltage	+5 V/GND, supply via the motor connector
Signal output	TTL level

10.1.3 Maximum Ratings

The U-624 rotation stages are designed for the following operating data:

Maximum Operating Voltage	Operating Frequency	Maximum Power Consumption
135 V _{pp} or 48 V _{eff}	275 to 290 kHz	20 W

10.2 Ambient Conditions and Classifications

The following ambient conditions and classifications must be observed for the U-624:

Area of application	For indoor use only
Maximum altitude	2000 m
Air pressure	1100 hPa to 0.1 hPa (corresponds to roughly 825 torr to 0.075 torr)
Relative humidity	Highest relative humidity 80 % for temperatures up to 31 °C Decreasing linearly to 50 % relative humidity at 40 °C
Operating temperature	0°C to 40°C
Storage temperature	-20 °C to 75 °C
Transport temperature	-20 °C to 75 °C
Overvoltage category	II
Protection class	I
Degree of pollution	1
Degree of protection according to IEC 60529	IP20

10.3 Motor Power

10.3.1 Motor Power and Operating Voltage

INFORMATION

The operating voltage is limited by the controller using the **Maximum Motor Output (V)** (ID 0x7c) parameter. If you load the operating parameters of the U-624 from the *PIStages2.dat* stage database, the parameter is set to the maximum permissible value.

The following table shows the relationship between the operating voltage and the motor power of the U-624. The operating voltage is output by the controller and depends on the actual control value. The polarity sign of the control value determines the direction of motion.

Motor Power	Operating Voltage* (Rounded)	Corresponding Control Value on the Controller**
0 %	0 V _{eff}	0
25 %	12 V _{eff}	8192 or -8192
50 %	24 V _{eff}	16384 or -16384
75 %	36 V _{eff}	24575 or -24575
100 %	48 V _{eff} (max.)	32767 or -32767

* Exceeding the maximum value in the **Maximum Motor Output (V)** (ID 0x7c) parameter is **not** permitted and can damage the motor.

** Generated in closed-loop operation via the control algorithm or set in open-loop operation via the `SMO` command.

For further information, see the user manual of the controller (p. 3) used to operate the U-624.

10.3.2 Velocity and Torque

The following figure can be used to estimate the velocity and torque of the U-624 with different motor powers. Motion is possible starting at a motor power of approx. 30 %.

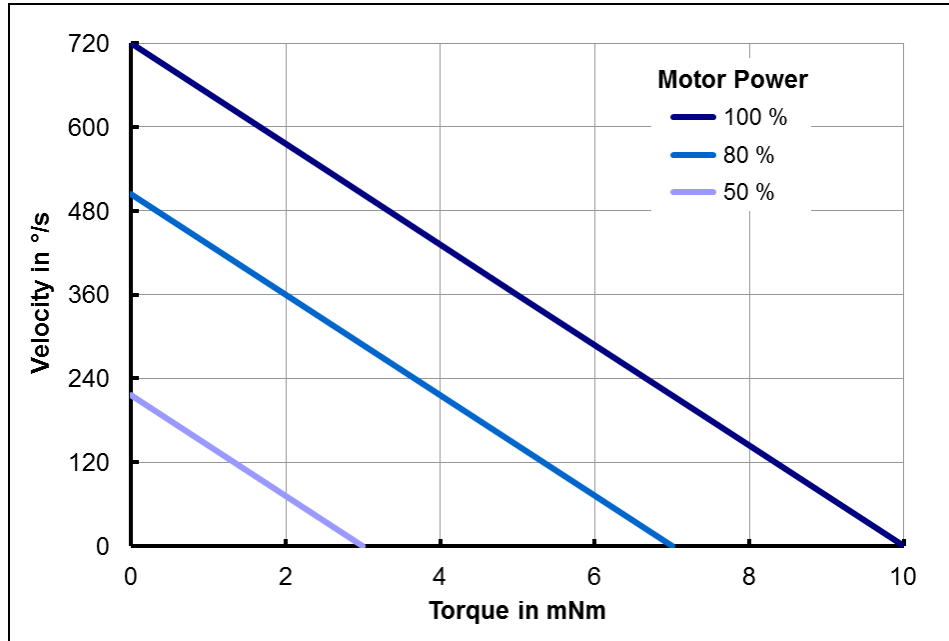

Figure 6: Relationship between velocity and torque of the U-624 with different motor power levels

10.3.3 Motor Power and Lifetime

Motor power, duty cycle and ambient temperature influence the lifetime of the rotation stage. In order to prevent overheating and high wear, the motor power and the duty cycle should not exceed the limits given in the following graph. A load cycle corresponds to a positioning run and includes the acceleration, motion, deceleration as well as downtime (break). The motor should only sporadically be operated at peak power; the peak power serves as a control reserve.

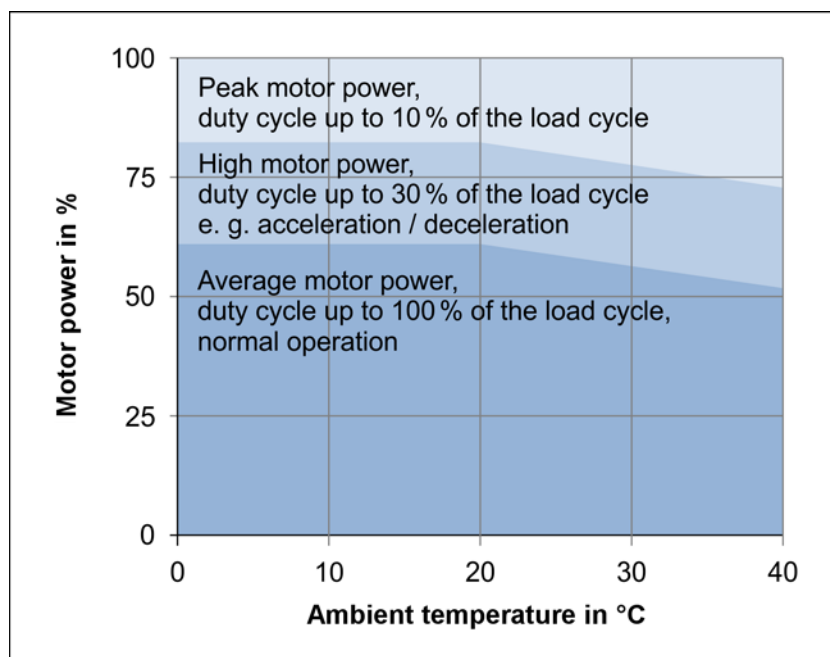

Figure 7: U-624: Recommended duty cycle and motor power depending on the ambient temperature

10.3.4 Influence of Downtimes on the Torque

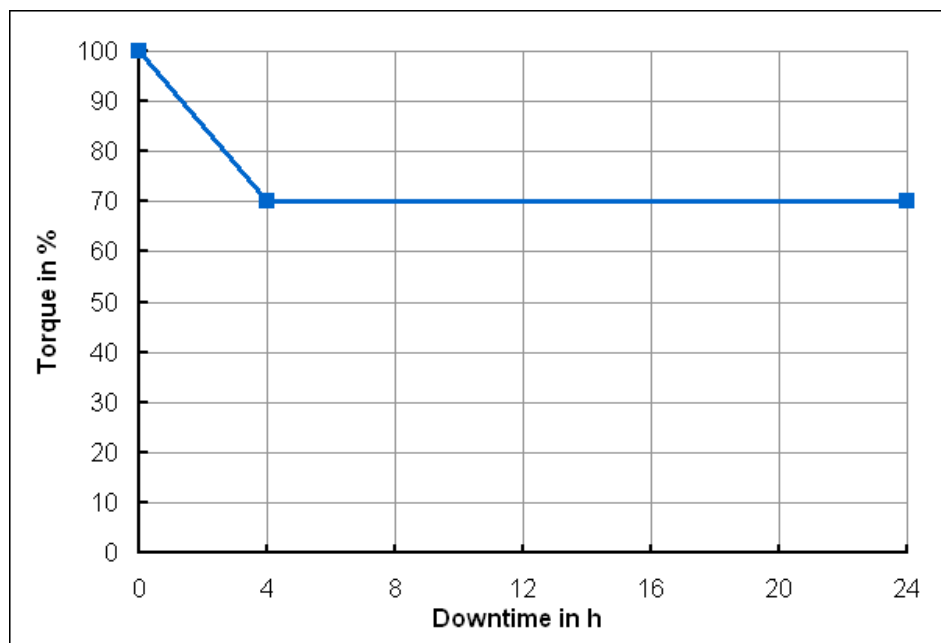

Figure 8: Torque of the U-624 depending on the downtime of the motor

10.4 Dimensions

Dimensions in mm. Note that the decimal places are separated by a comma in the drawings.

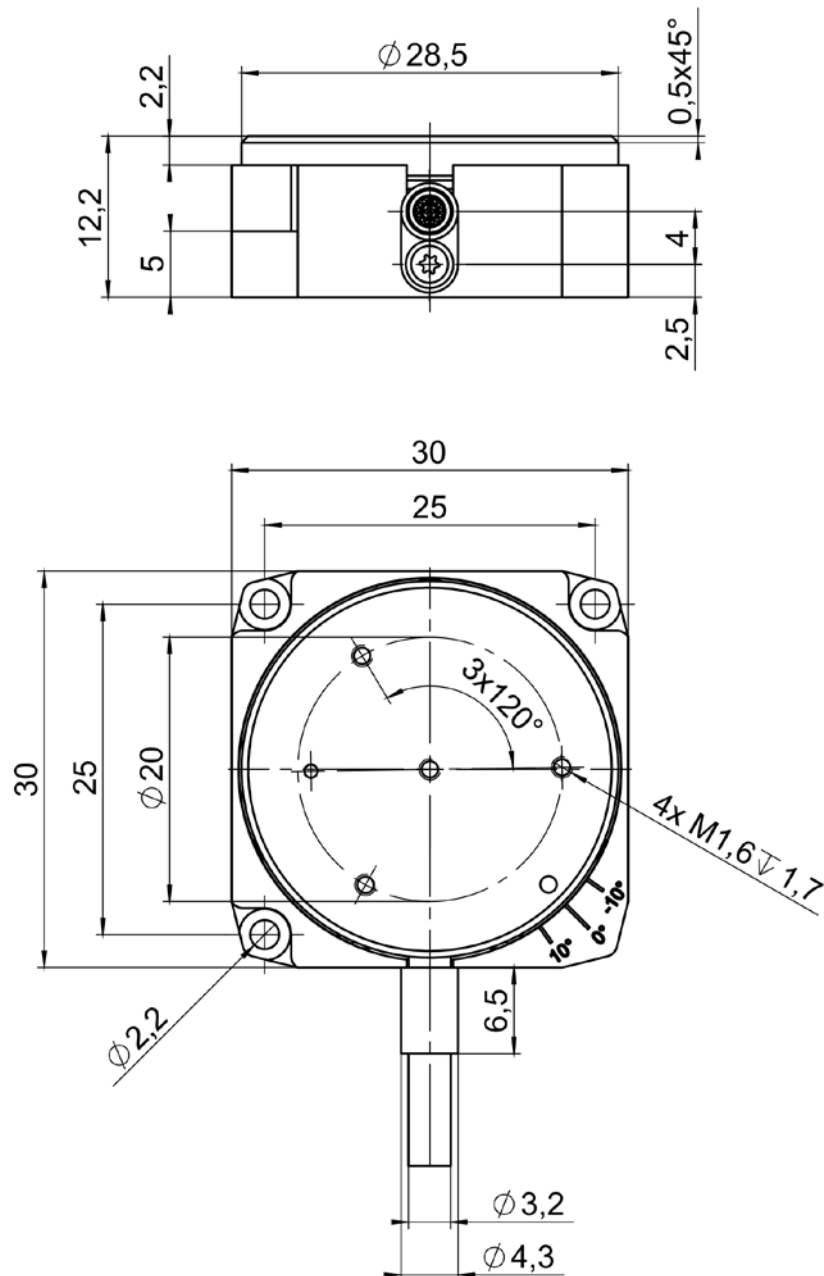

Figure 9: U-624, moving platform in reference position

10.5 Pin Assignment

Connector: Sub-D 15 (m)

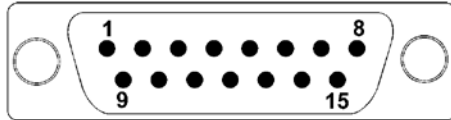

Figure 10: Front view of the Sub-D 15 connector

Pin	Signal	Function
1	NC	Not connected
2	USM_P1	Input: Piezo 48 VAC (RMS)
3	USM_P2	Input: Piezo 48 VAC (RMS)
4	VDD	Input: +5 V
5	NC	Not connected
6	ID_CHIP	Bidirectional: Data line for ID chip
7	ENCA-	Output: Encoder channel A (inverted), RS-422
8	ENCB-	Output: Encoder channel B (inverted), RS-422
9	USM_P1	Input: Piezo 48 VAC (RMS)
10	GND	0 V
11	USM_P3	Input: Piezo 48 VAC (RMS)
12	NC	Not connected
13	REFSWITCH	Output: Reference point switch
14	ENCA+	Output: Encoder channel A, RS-422
15	ENCB+	Output: Encoder channel B, RS-422

11 Old Equipment Disposal

In accordance with EU law, electrical and electronic equipment may not be disposed of in EU member states via the municipal residual waste.

Dispose of your old equipment according to international, national, and local rules and regulations.

In order to fulfil its responsibility as the product manufacturer, Physik Instrumente (PI) GmbH & Co. KG undertakes environmentally correct disposal of all old PI equipment made available on the market after 13 August 2005 without charge.

Any old PI equipment can be sent free of charge to the following address:

Physik Instrumente (PI) GmbH & Co. KG
Auf der Roemerstr. 1
D-76228 Karlsruhe, Germany



12 EC Declaration of Conformity

For the U-624, an EC Declaration of Conformity has been issued in accordance with the following European directives:

2006/95/EC, Low Voltage Directive

2004/108/EC, EMC Directive

2011/65/EU, RoHS Directive

The applied standards certifying the conformity are listed below.

Safety (Low Voltage Directive): EN 61010-1:2010

EMC: EN 61326-1:2013

RoHS: EN 50581:2012

